



Intelligent Remote Control
Télécommande intelligente

RAV-2000

*OWNER'S MANUAL
MODE D'EMPLOI
BEDIENUNGSANLEITUNG
BRUKSANVISNING*



CAUTION

Read this before operating the Remote Control

- To assure the finest performance, please read this manual carefully. Keep it in a safe place for future reference.
- To avoid failure, do not spill liquid on the Remote Control.
- Be sure to read the 'Troubleshooting' section on common operating errors before concluding that the Remote Control is faulty.

UNPACKING

Check your package to make sure it has following items.

- RAV-2000 Intelligent Remote Control
- Computer Interface Cable (RS-232C)
- Owner's manual
- Four AA 1.5V Batteries

Table of contents

English

Introduction	2
1. Intelligent Remote Control	2
2. Installing the Batteries	3
Getting Started	4
1. Activating the Remote Control	4
2. Defining the Brands of Your Devices	5
3. Adjusting the Settings	9
Controlling your Home Theater	10
1. General Operation	10
2. Operating an A/V amplifier	12
3. Selecting a Device	13
4. Controlling Power on/off of your A/V devices	14
Getting the Most Out of It	16
1. Introduction	16
2. Redefining Brands	17
3. Learning Commands	18
4. Labeling Elements	21
5. Adding and Moving	23
6. Deleting and Restoring	25
7. Recording Macros and Setting Timers	27
8. RAVedit	32
Appendix	33
Troubleshooting	33
FAQ	35
Specifications	37

Introduction

1. Intelligent Remote Control

The Intelligent Remote Control can be used with most devices that understand infrared (IR) remote control signals. Its easy-to-use touch screen and its intuitive interface make it the perfect remote control for every user.

The Remote Control (RC) is completely customizable. In the memory of the Remote Control, RC codes are stored to activate different brands of all kinds of video and audio devices. The Remote Control is set up by default to operate with YAMAHA devices. If you have other brands, you simply define the brands of your devices when you use the Remote Control for the first time.

The Remote Control can also learn RC codes from existing remote controls. It is designed to add devices and functions, relabel buttons, record macros and set timers. With the RAVedit software you create your own control panels and define your personal look.

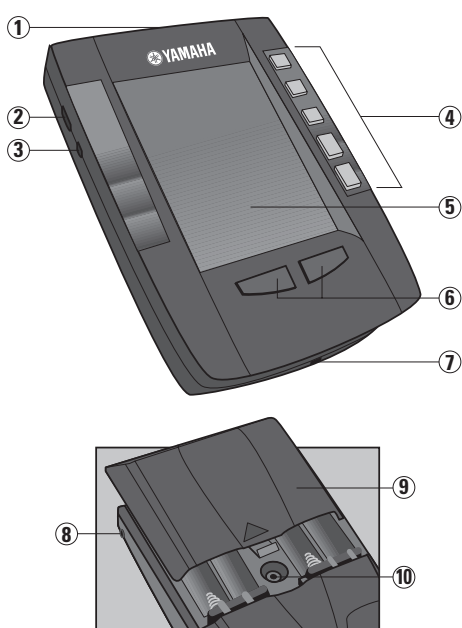

- 1 sending eye
- 2 contrast dial
- 3 backlight button
- 4 direct-access buttons
- 5 touch screen
- 6 Left/Right buttons
- 7 learning eye
- 8 serial port
- 9 battery door
- 10 reset button

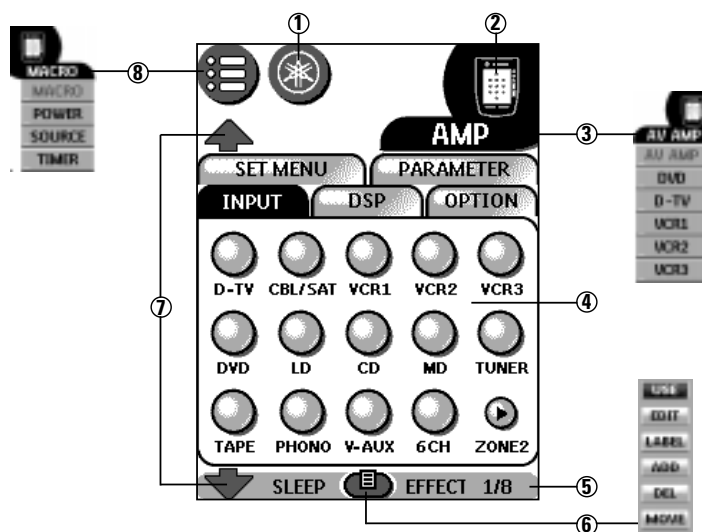

- 1 Home: to go to the Home menu
- 2 Remote Control icon: Touch and hold to enter Setup
- 3 Device menu: to open device control panels
- 4 Control panel: to send commands to components
- 5 Panel number: shows active control panel
- 6 Mode menu: to customize the Remote Control
- 7 Scroll buttons: to display previous and next control panel
- 8 Macro menu: to open stored list of commands

2. Installing the Batteries

- 1 Slide the battery door off the back of the Remote Control.
- 2 Insert 4 AA batteries (included with the Remote Control) as indicated on the bottom of the battery compartment.

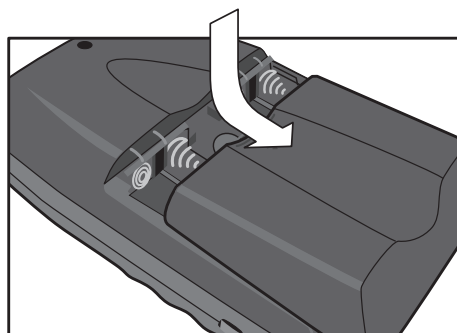

- 3 Slide the battery door back on.
After a few seconds, the Remote Control starts up automatically and beeps twice to indicate that it is ready to use.

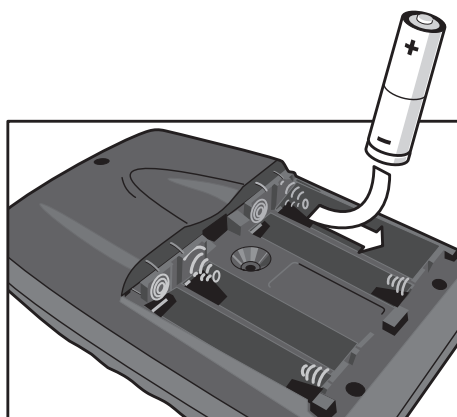

When batteries are running low, the Low Battery icon  flashes at the center top of the display. Replace the batteries as soon as possible to ensure perfect performance.

Note The Remote Control retains all settings when the batteries have discharged or when you remove and replace them. You will need only to reset the clock.

Notes on batteries

- Do not use old batteries together with new ones.
- Do not use different types of batteries (such as alkaline and manganese batteries) together.
Read the packaging carefully as these different types of batteries may have the same shape and color.
- Do not use rechargeable batteries.
- If the batteries have leaked, dispose of them immediately. Avoid touching the leaked material or letting it come into contact with clothing, etc. Clean the battery compartment thoroughly before installing new batteries.

Getting started

1. Activating the Remote Control

Turning on the display

- Tap the screen gently with your finger or a blunt, soft object like a pencil eraser. The display is activated and the Home menu appears.

Notes

- If the display stays blank or becomes black, adjust the contrast dial on the left side.
- If another panel is displayed, tap the Home button.
- The Remote Control shuts down automatically.

Using the backlight

- Press the backlight button on the left side. The backlight shuts off after a few seconds to save power.

Note In the settings, you can choose to activate the backlight automatically when you turn on the Remote Control.

Activating Modes

The Remote Control has different modes.

When controlling devices, the Remote Control should be set to Use mode. If a label (like **BRAND** or **LEARN**) appears at the top center of the touch screen, see page 17 for information or switching your Remote Control to Use mode.

2. Defining the Brands of your Devices

The Remote Control uses RC codes to activate devices. Because there are several brands using specific RC codes, you have to define the brands of your devices.

The Remote Control is set up by default to operate with YAMAHA devices.

- 1 Tap scroll button  to go to second (or third) control panel.

A/V devices are listed in the second and third control panel.

- To select amplifier, tap  .

- 2 Tap a device name to select the desired device.
- 3 If the brand of your device is YAMAHA, click No.

The Remote Control switches to Use mode.

-or-

If you want to adjust the Remote Control to operate with your brand, click Yes.

The Remote Control switches to Brand mode. Follow the instructions as described below. You can define your brands by selecting or by searching.

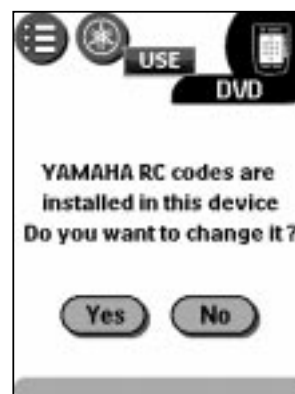

Note Before you start using the Remote Control, make sure you define the brand for each device you want to operate.

Defining brands by selecting

A list of brands and their corresponding RC codes are stored in the Remote Control's memory.

Select your brand from the list. Because not every device of a certain brand uses the same RC codes, you might also need to select from a set of RC codes for your brand.

- 4 Tap Next.

A scrollable list of brands for the selected device and a "virtual auto-zooming" mini-keyboard appears.



Getting started

5 Navigate the list of brands.

Use the scroll buttons to scroll up or down the list.

- By tapping the scroll buttons, you scroll through the brands one by one.
Holding down a scroll button increase the scrolling speed.
- Use the mini-keyboard to jump through the list of brands.
To enter a character, tap near it on the keyboard.

The keyboard zooms in, allowing you to tap exactly the character you need.

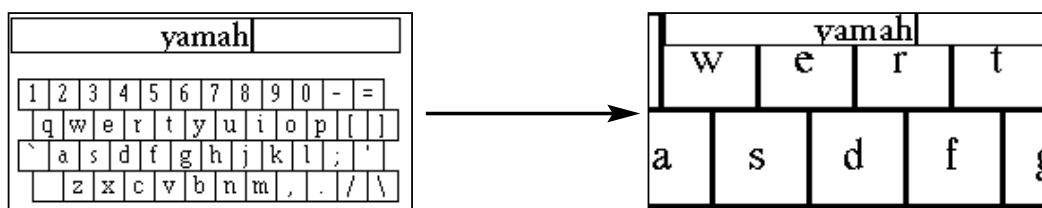

To enter a space, tap the lower left corner of the keyboard.

When the keyboard zooms in, tap the empty key.

After you tap the character, the keyboard zooms out.

Repeat this action for every character.

Every time you enter a character the list displays the brands that match the character(s). The Remote Control makes a pre-selection of the (first) brand that matches.

You have to type only as many characters as needed to display your brand.

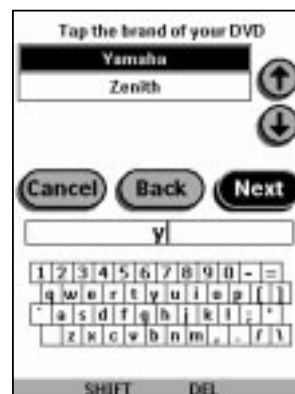

Note When your brand is not displayed in the list of brands, you can use Search mode. See "Defining brands by searching" on page 7.

6 Select your brand in the list.

The selected brand turns black. The Search button becomes the Next button.

7 Tap Next.

When your brand uses only one set of RC codes, the Remote Control switches to Try mode. Continue with step 10.

When there are several code sets for your brand, the following screen appears.

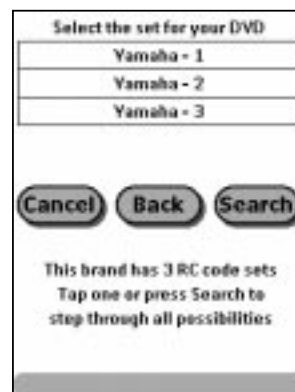

Notes · The code sets are ranked. The first code set in the list is used for most devices of the selected brand.

· When you do not know which code set to select from the list, you can use Search mode. See "Defining brands by searching" on page 7.

8 Select a code set from the list.

The selected code set turns black. The Search button becomes to Next.

9 Tap Next.

The Remote Control switches to Try mode. The first control panel of the selected device is displayed.

10 Try out the buttons on the different control panels and check whether the device responds to the RC codes the Remote Control is sending.

Note Even when your device is responding to the current code set, it is advised to try out other code sets. When your device responds to more than one code set, install the most suitable one.

11 If you are not satisfied with the way the device responds to the selected code set, tap Back to select another code set.

-or-

If you are satisfied with the selected code set, tap Install.

When the RC codes for your device are installed, the Remote Control beeps and returns to Use mode. Your brand is now defined for the selected device.

12 Define other devices you want to operate.

Defining brands by searching

You can use Search mode to find the matching RC codes for your device when:

- your brand is not displayed in the list of brands,
- you selected your brand, but do not know which code set to select.

4 Tap Next.

The display shows a scrollable list of brands for the selected device and a "virtual auto-zooming" mini-keyboard.

5 Tap Search.

The Remote Control automatically searches through all available brands and code sets to find the matching RC codes for your device.

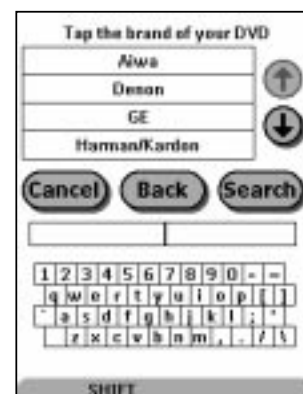

Getting started

- 6 Tap Next to start sending appropriate commands for the selected device.
- 7 Tap OK when the device reacts.

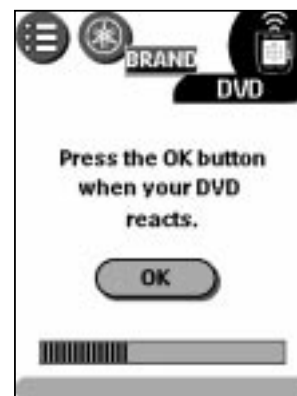

Notes

- Even when the device is responding to the current code set, it is still advisable to try out other code sets. When your device responds to more than one code set, install the most suitable one.
- The name of the responding code set is displayed when you tap the OK button, so you know which code set to select from the list after you try out other code sets.

The Remote Control switches to Try mode. The first control panel of selected device is displayed.

- 8 Try out the buttons on the different control panels and check whether the device is responding to the RC codes the Remote Control is sending.
- 9 If you are not satisfied with the way the device is responding, tap Back to continue the automatic search.

-or-

If you are satisfied with the selected code set, tap Install.

When the RC codes for your device are installed, the Remote Control beeps and returns to Use mode. Your brand is now defined for the selected device.

- 10 Define other devices you want to operate.

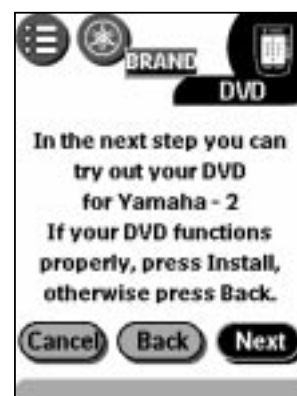

3. Adjusting the Settings

Most of the Remote Control's features can be set to suit your preferences.

1 Touch and hold the Remote Control icon for a few seconds.

The first setup panel appears. You can display the second and third setup panel by using the scroll buttons. The third panel provides technical information about your Remote Control.

2 Tap the button for the setting you want to adjust.

The button turns black.

3 Use the Left and Right buttons to adjust the setting.

Setting	Function	Adjusting
Battery	<i>Shows the battery level.</i>	
Clock	<i>Turns the clock display on or off and lets you set 12 or 24h time display.</i>	<i>Tap the clock repeatedly</i>
Time	<i>Sets the clock.</i>	<i>Tap the time button and use the Left and Right buttons.</i>
Day	<i>Sets the day.</i>	<i>Tap the day button and use the Left and Right buttons.</i>
LCD	<i>Sets how long the touch screen stays on.</i>	<i>Tap the LCD button and use the Left and Right buttons.</i>
LCD	<i>Light Sets how long the backlight of the touch screen stays on.</i>	<i>Tap the LCD Light button and use the Left and Right buttons.</i>
Button Light	<i>Sets how long the backlight of the direct-access buttons stays on.</i>	<i>Tap the Button Light button and use the Left and Right buttons.</i>
Mode Menu	<i>Hides or shows the Mode button.</i>	<i>Tap the Mode Menu button.</i>
Touch	<i>Adjusts or turns off the touch screen beep.</i>	<i>Tap the Touch button repeatedly.</i>
Button	<i>Adjusts or turns off the beep of Left/Right and direct-access buttons.</i>	<i>Tap the Button button repeatedly.</i>
Calibrate	<i>Calibrates the touch screen.</i>	<i>Tap the Calibrate button and follow the on-screen instructions.</i>
Revert	<i>Reverts the Remote Control to the factory default configuration.</i>	<i>Tap the Revert button and follow the on-screen instructions.</i>

To exit Setup Mode

Tap the Remote Control icon.

The Remote Control returns to Use mode.

Controlling your Home Theater

The Remote Control is designed to control all devices in your home theater. You can select the device you want to control via the Home menu.

■ Tap  to operate your A/V amplifier or receiver.

■ Tap  to select a video device.

Tap  to select an audio device. The input source of the amplifier automatically changes to the selected device.

You can also select a device by scrolling down to the second or third home panel and tapping the name of the device you want to operate.



■ Tap  to display the power control panels.

■ Tap  to display the device control panels.

■ Tap  to use macros.

1. General Operation

You operate devices using three kinds of buttons:

- Touch screen buttons
- Left and Right buttons (below the touch screen)
- Direct-access buttons (to the right of the touch screen)

Using touch screen buttons



Sending commands

By tapping the touch screen buttons you send commands to the device you have selected. When you send a command, the

Remote Control icon  indicates that it is transmitting signals. The name of the active device is indicated on the device tab.



Scrolling

Most devices have more than one control panel. You can scroll through these control panels using  and . The panel number on the left bottom of the screen indicates the active panel number and the total number of panels, for example **1/5**.

By holding down a scroll button, you cycle repeatedly through all the control panels of a device.

Switching to another device without affecting the active device

If you switch to another device (for which you already defined a device action), RC codes are sent out the moment you select the device.

To switch to another device without sending RC codes, follow this procedure.

Example

You defined a device action for the VCR1: when you select the VCR1, the D-TV switches to channel 10. Now you wish to keep watching channel 2 on the D-TV when you switch to the VCR1 to rewind a tape.

- 1 Open the device menu.
- 2 Press and hold the Left or Right button (labeled *NO IR*).

The Remote Control icon turns around , indicating that the device you are going to select will not send IR codes so as not to affect the active device.

- 3 Tap the device you want to select.

The control panel of the new selected device appears and the Remote Control icon returns to its original position. You can now operate the new selected device without affecting the previously active device.

Using the Left and Right buttons

The Left and Right buttons change function depending on the device the Remote Control is operating. The current function is displayed on the touch screen right above the button. The function can be an IR command which is transmitted, or a jump to a specific device page.

Using the direct-access buttons

You can operate your A/V amplifier with the direct-access buttons (POWER, STANDBY, MUTE, VOL +/-) at any time, even without turning on the touch screen.

Controlling your Home Theater

2. Operating an A/V amplifier

The Remote Control provides you with 8 pages of intuitive control panels for operating a YAMAHA A/V amplifier.

Note Since there are multiple RC codes for YAMAHA A/V amplifiers (or receivers), your YAMAHA amplifier may not respond to the default command from the Remote Control. In that case you need to select another RC code. See page 5, "Defining the Brands of Your Devices" for information on selecting another RC code.

Item tabs

Tap an item tab to select the item you want to operate.

INPUT: You can select a source device.





DSP: You can select a DSP sound field program.

The controls  can be used to select one of three DSP panels.

OPTION: By default there are buttons to select main speakers A/B, zone 2, etc., appear.

SET MENU: You can adjust the items on the set menu.

If your amplifier has an on-screen display function, tap  to show the set menu on a video monitor connected to the amplifier.

Select the item using  or , then adjust the setting of the item using  or . (Some items require extra steps.).

Tap  to select the effect speaker channels so you can adjust their level independently.

PARAMETER: You can change the parameter settings of each DSP program.

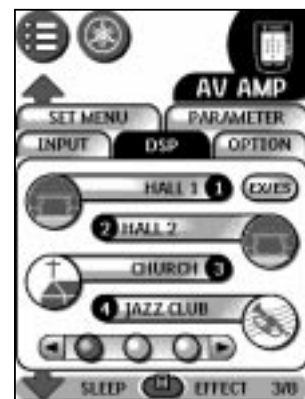

Left and Right buttons

While any of AMP menu panel appears on the touch screen, you can use the left and right buttons for the following operations.

Turning DSP on and off : You can turn the DSP effect on and off directly with the right button (EFFECT).

Sleep timer: You can set the sleep timer on your amplifier with the left button (SLEEP).

Each time the button is pressed, the amount of time before the amplifier automatically turns off changes as shown on the front panel display of the amplifier.



- To cancel the sleep timer, press the left button repeatedly until 'SLEEP OFF' appears on the front panel display of the amplifier.



Controlling your Home Theater

3. Selecting a Device

Via the Home menu

- 1 Tap  or  to select a video (or audio) device.

The Remote Control displays buttons that enable you to select your devices. If you cannot find the device you want to select on the first panel, scroll through the pages using .

-or-

Tap  to display the second (or third) home menu panel.

- 2 Tap the device you want to operate.

The first control panel of the selected device appears.

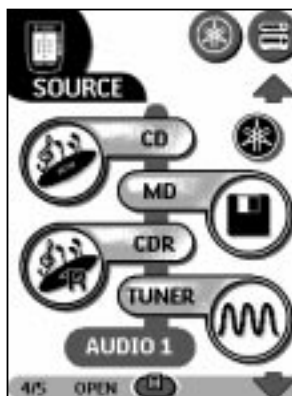
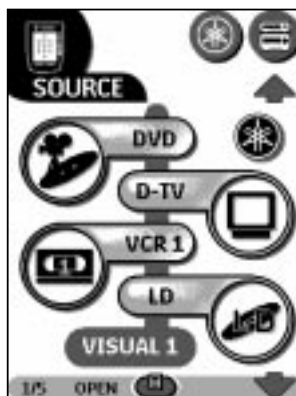



or



Via the Device menu

The Device menu allows you to easily switch to another device without having to return to the Home menu.

- 1 From within any device control panel, tap the device tab.

The Device menu pops up. You can scroll through this menu using  and .

Controlling your Home Theater

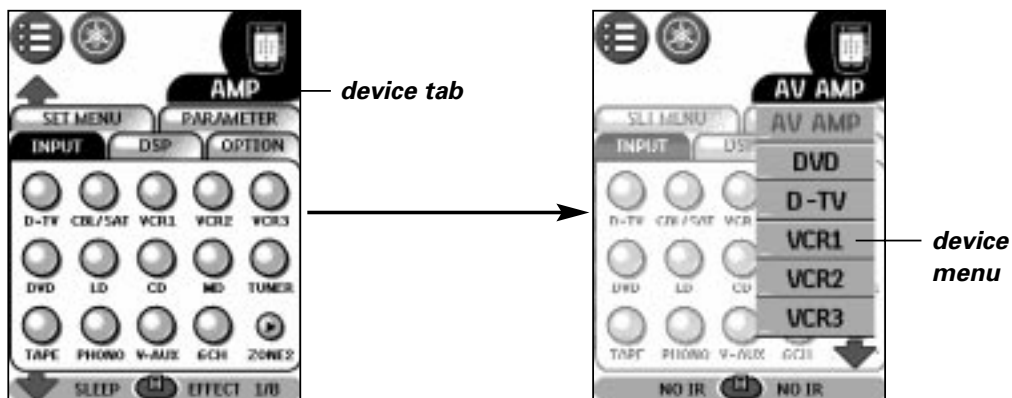

- 2 In the Device menu, tap the device you want to operate.
The control panel that was last accessed for the device appears.

Note You can also activate the Device menu from Home by tapping the device tab icon.

4. Controlling Power on/off of your A/V devices

Using the Power control panel, you can simultaneously turn on or off (standby) multiple devices without switching the control panel for each device.

- Notes*
- This function is effective only with devices that have a power on/off button on their original remote control.
 - Most of the device buttons listed below power groups (e.g., **ALL VISUAL**, **ALL AUDIO**) are not assigned commands by default. If the remote control of your device has a power on/off button, you can assign a command by defining the brand of the corresponding device. See page 5 to define the brand of your devices.
 - You cannot turn your A/V amplifier on or off using the buttons on the power control panel. Use direct-access buttons to turn the A/V amplifier on or off (standby).

- 1 Tap  on the home menu panel.
- or -
Open the Macro menu and tap POWER.



- 2 Tap a power group button.
 - To turn on /off the power for all devices at once, tap **ALL DEVICES**.
 - To turn on/off the power for the video devices one at a time, tap **ALL VISUAL**.



Controlling your Home Theater

- To turn on/off the power for the audio devices one at a time, tap .

Whether a device turns on or off depends on the previous state of each device. Tap the buttons of each device to turn on or off the devices individually.

Note You can add or move devices and assign their power on/off commands on the list below ,  or  (power group).
See page 28 "Recording macros".

Getting the most out of it

1. Introduction

The Remote Control is set up by default to operate with YAMAHA devices. When you have other brands, you can define the brands for your devices and install the RC codes to activate those devices.

What makes the Remote Control so powerful is the ability to extend its functionality in multiple ways like programming additional functions, adding supplementary devices, recording macros and customizing the interface as it suits you best.

Working with Modes

When you operate your devices, the Remote Control is in Use mode. For actions other than operating (like programming buttons, recording macro's, adding devices, and so on) you have to switch to the appropriate mode:

USE

For operating devices.

LEARN

For learning commands from other devices.

EDIT

For recording macros and setting timers.

LABEL

For labeling buttons and commands.

ADD

For adding new devices.

DEL

For deleting buttons, devices and macros.

MOVE

For changing the order in a menu.

BRAND

For defining brands using the Remote Control's database.

Switching to another mode

- 1 Tap the Mode button  at the bottom of the touch screen.
The Mode menu pops up.
- 2 Tap the mode you want to use.
The label of the active mode appears on the top center of the touch screen.
You can now work in the selected mode.

Hiding the Mode menu

To prevent accidental changes to the Remote Control interface and commands, you can hide the Mode menu:

- 1 Make sure the Remote Control is in Use mode.
- 2 Touch and hold the Remote Control icon for a few seconds.
The first setup panel appears.
- 3 Scroll down to the second setup panel.
- 4 Tap the Mode Menu button.
The mode menu icon is crossed out.
- 5 Tap the Remote control icon.
The Remote Control switches to Use mode. The Mode button is no longer visible.

2. Redefining Brands

If you purchase a new device with a brand that you have not yet defined in the Remote Control, you need to redefine the brand to activate your new device.

You can redefine brands by selecting or by searching.

■ Redefining brands by selecting

- 1 Switch to Brand mode via the Mode button .
The Device menu pops up.
- 2 Select the device for which you want to redefine the brand.
- 3 Complete instructions 4 to 11 in “Defining brands by selecting”.
- 4 Redefine all the other devices you want.

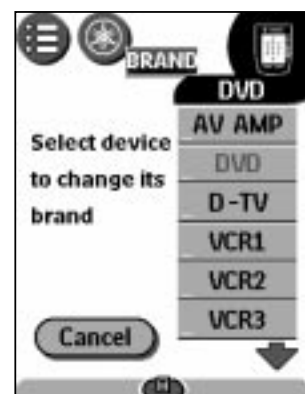

Getting the most out of it

■ Redefining brands by searching

You can use Search mode to find the matching RC codes for your device when:

- your brand is not displayed in the list of brands,
- you selected your brand, but do not know which code set to select.

1 Switch to Brand mode via the Mode button .

The Device menu pops up.

2 Select the device for which you want to redefine the brand.

3 Complete instructions 4 to 9 in “Defining brands by searching”.

4 Redefine all the other devices you want.

3. Learning Commands

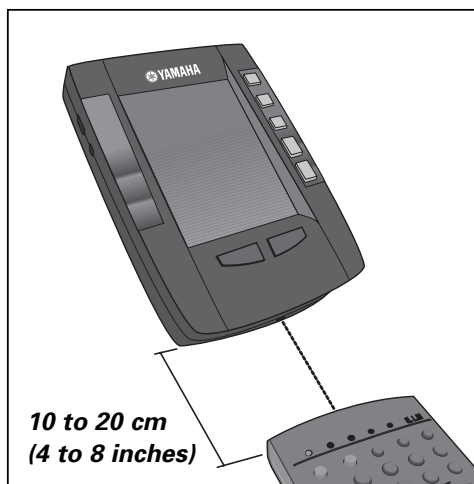

You can program the Remote Control commands by transmitting IR signals from your existing remote controls to the Remote Control's learning eye.

To do this, place the Remote Control and the device's remote control on a flat surface, 10 to 20 cm (4 to 8 inches) apart.



The following buttons can be programmed:

- Control panel buttons,
- Device actions,
- Direct-access buttons and Left/Right buttons.

You cannot program Home menu buttons directly. You must program devices via the Device menu.

The Remote Control also offers empty control panel buttons that you can program and label as existing buttons. They are visible only in Learn and Label mode and appear with or without labels (intended for a specific function). You will also see previously deleted buttons: you can restore them by reprogramming them or you can reuse them for other commands.

Learning control panel buttons

- 1 Navigate to the control panel buttons you want to program.
- 2 Switch to Learn mode via the Mode button .
Additional empty buttons appear: they can be programmed and labeled as existing buttons.
- 3 Point the device's original remote control at the Remote Control's learning eye.
- 4 Tap the Remote Control button you want to program.
The button starts flashing.
- 5 Press and hold the corresponding button on your device's original remote control.
If the Remote Control has learned the command successfully, OK flashes on the Remote Control icon. You can release the button you're holding.
If the Remote Control has not learned the command successfully, you will hear a short beep and FAIL will appear on the Remote Control icon.
- 6 Program all other buttons you want and relabel them if necessary.
- 7 Return to Use mode via the Mode button .

Learning device actions

A device action is a command that is assigned to a Device button on the Home menu or a device in the Device menu. The action is executed every time you select the device.

Note When you program a device action, RC codes are sent the moment you select the device. This might affect the operation of the active device. For information on switching to another device without sending RC codes and without affecting the active device. See "Switching to another device without affecting the active device" on page 11.

- 1 Make sure the device tab is active.
The device tab is active when the name of a device is displayed.
- 2 Switch to Learn mode via the Mode button .
- 3 Point the device's original remote control at the Remote Control's learning eye.
- 4 Tap the device tab to open the Device menu.
- 5 Touch and hold the Remote Control's Left or Right button (both labeled *Device*) and tap the device you want to program.
Even when you want to program a device action for the currently active device, you must tap it in the Device menu.
The label device starts flashing on the Remote Control icon.

Getting the most out of it

- 6 Press and hold the button you wish the Remote Control to learn as device action on your device's original remote control. The command for the device action is assigned to the Device button in the Home menu and in the Device menu.

If the Remote Control learns the command successfully, OK flashes on the display. You can release the button you're holding.

If the Remote Control has not learned the command successfully, you will hear a short buzz and FAIL will appear on the Remote Control icon.

- 7 Program all the other device actions you want and return to Use mode via the Mode button .

Learning Direct-access and Left/Right Buttons

Direct-access and Left/Right buttons can be programmed with a global function or with functions per device.

- Buttons with global functions always execute the same command, no matter what device is active.
- Buttons with functions per device execute commands depending on the active device.

Note Per device functions override global functions. For example, when you program the Volume buttons globally, but assign a specific function to them with the tuner, the specific command will be executed when the tuner is the active device.

Learning a button per device

- 1 Switch to the device for which you want to program the button.
- 2 Complete steps 2 to 7 in "Learning control panel buttons" on page 19. Instead of tapping a button on the touch screen, press the direct-access button or Left/Right button you want to program.

The label of the button you press (e.g. vol+ or left) starts flashing at the top center of the touch screen.

Learning a button globally

- 1 Tap the Home menu button .
- 2 Complete steps 2 to 7 in "Learning control panel buttons" on page 19. Instead of tapping a button on the touch screen, press the direct-access button or Left/Right button you want to program.

The label of the button you press (e.g. vol+ or left) starts flashing at the top center of the touch screen.

Getting the most out of it

4 Edit the label.

- To delete a character, press the Right button (labeled *Del*).
- To enter a character, tap the keyboard near the character you want to use.
The keyboard zooms in, allowing you to tap exactly the character you need.

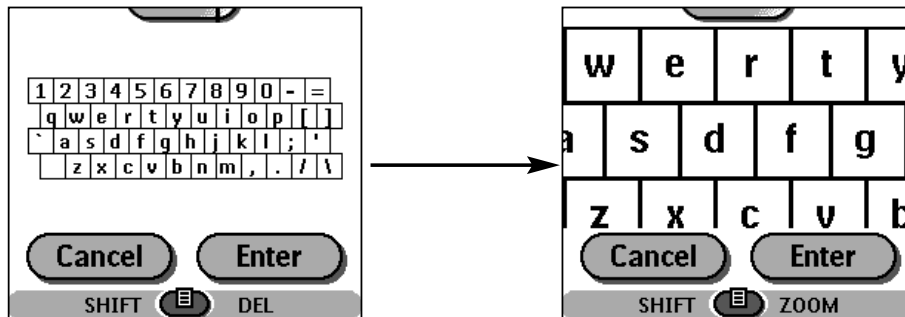

To enter a space, tap the lower left corner of the keyboard. When the keyboard zooms in, tap the empty key.

After you tap the character, the keyboard zooms out. Repeat this action for each character.

Note You can zoom out again without tapping a character by pressing the Right button (labeled *Zoom*).

- For capital letters and symbols, press the Left button (labeled *Shift*) repeatedly to display the keyboard you want.

5 Tap Enter to save the changes and return to the previous panel,

-or-

Tap Cancel to return to the previous panel without saving changes.

6 Label all the other elements you want and return to Use mode via the Mode button.

Labeling a device

1 Switch to Label mode via the Mode button .

2 Tap the device tab to open the Device menu.

3 Touch and hold either the Remote Control's Left or Right button (labeled *Device*) and tap the device you want to label.

Even when you want to label the currently active device, you must tap it in the Device menu.

The display shows a "virtual auto-zooming" mini-keyboard. The button you want to label is displayed above the keyboard.

4 Complete steps 4 to 6 on page 21 in "Labeling a button".

5. Adding and Moving

Adding a device

If you have a device that is not listed in the Device menu, you can add it to the Remote Control.

You cannot add devices to the Home menu directly. You must add them via the Device menu.

1 Make sure the device tab is active.

The device tab is active when the name of a device is displayed.

2 Switch to Add mode via the Mode button .

The Remote Control displays the following choices:

- Create New Device: Choose this option to add a completely new device.
- Copy Existing Device: Choose this option to copy a device already listed in the Device menu (for example for a second DVD).
- Restore Deleted Device: Use this option to restore a device you have deleted.

3 Tap the device you want to add in the Device menu.

Note If the device you want to add is not listed, choose a similar one. You can customize it later.

The Remote Control allows you to add new devices with or without RC codes.

- Create with RC codes: Choose this option if you think the new device understands RC codes. The new device is added with operational buttons.
- Don't add RC codes: If you choose this option, the new device is added without operational buttons. You will then have to program them as explained in "Learning control panel buttons".

You cannot define a device in Brand mode, because there are no RC codes available.

4 Tap the button of your choice.

The new device is automatically displayed in Use mode.

Note A new device tab is automatically created in the device menu and in the third home menu panel. However, you cannot add the button of the new device to the audio/visual source panels.

Getting the most out of it

Moving a device, macro group or timer group

You can change the order in the Device menu and the Macro menu. Changes you make in the Device menu are automatically updated in the Home menu.

1 Make sure the device tab or macro tab is active.

The device or macro tab is active when the name of a device, macro or timer is displayed.

2 Switch to Move mode via the Mode button .

The Remote Control displays the menu.

3 Tap the device or group you want to move.

The menu item is highlighted.

4 Use the Left and Right button to move the menu item up or down.

5 Tap Accept to save the changes.

You return to Use mode.

Note: The item at the top of the device tab corresponds to  on the first home menu panel.

If you move the AMP tab down, it is advisable to label  with the name of the item at the top of the device menu.

6. Deleting and Restoring

Deleting

You can delete the following elements:

- Control panel buttons and actions associated with a direct-access or a Left/Right button,
- Device actions,
- Devices, macro groups and timer groups.

Home menu buttons cannot be deleted directly. You must delete them via the Device menu.

Note Buttons that are programmed in Learn mode and deleted afterwards will disappear from the display. When you redefine the device in Brand mode, those buttons will stay empty. You will need to program them again in Learn mode.

Deleting a button or button action

Note Shadeless buttons like  cannot be deleted. You can only hide them by removing their label. See "Labeling a button" on page 21.

1 Switch to Delete mode via the Mode button .

2 Tap the button you want to delete.

3 Tap Delete Button Action.

The result depends on the element you are deleting:

- Control panel button: The button disappears from the display.
- Left or Right button command: The corresponding label disappears from the display.
- Direct-access button: The button becomes inactive.

4 Delete all the buttons and button actions you want and return to Use mode via the Mode button.

Deleting a device action

1 Switch to Delete mode via the Mode button .

2 Tap the Device tab.

When you open the Device menu, the Left button label changes to Device and the Right button label changes to Action.

3 Press and hold down the Right button (labeled *Action*).

4 Tap the device associated with the device action you want to delete.

5 Tap Delete Device Action.

The device action is deleted.

6 Delete all the device actions you want and return to Use mode via the Mode button.

Getting the most out of it

Deleting a device, macro group or timer group

- 1 Switch to Delete mode via the Mode button .
- 2 Navigate to the device or group you want to delete.

If you have opened the Device menu, the Left button label changes to Device and the Right button label to Action.

If you have opened the Macro menu, the Left and Right button labels change to Group.
- 3 Press and hold down the Left or Right button depending on what you are deleting:
 - Left button labeled *Device*: To delete a device in the Device menu.
 - Left or Right button labeled *Group*: To delete a macro group or a timer group in the Macro menu.
- 4 Tap the device or group you want to delete.
- 5 Tap Delete Device, Delete Macro Group or Delete Timer Group.

The Device (and its associated Home menu button), the Macro Group (including its macros) or the Timer Group (including its settings) is deleted.
- 6 Delete all the devices, macro groups and timer groups you want and return to Use mode via the Mode button.

Restoring

When you delete elements, they are no longer visible in Use mode but remain in the Remote Control's memory. This allows you to restore them.

- You can restore a deleted a button or a device action in Learn mode.
- You can restore a deleted a device, macro group or timer group in Add mode.

Actions associated with direct-access or a Left/Right buttons cannot be restored. You must reprogram them as explained in "Learning Direct-access and Left/Right Buttons" on page 20.

Restoring buttons and button actions

- 1 Switch to Learn mode via the Mode button .
- The empty buttons become visible.
- 2 Complete steps 3 to 7 in "Learning control panel buttons" on page 19.

The button is restored.

Restoring device actions

- 1 Switch to Learn mode via the Mode button .
- 2 Complete steps 3 to 7 in "Learning device actions" on page 19.

The device item is restored.

Restoring devices, macro groups or timer groups

- 1 Make sure the device tab or macro tab is active.**
The device or macro tab is active when the name of a device, macro or timer is displayed.
- 2 Switch to Add mode via the Mode button .**
- 3 Tap Restore Deleted Device or Restore Deleted Group.**
The deleted devices, macro groups or timer groups become visible.
- 4 Tap the item you want to restore.**
The item is restored and you return to Use mode.

Note Only the macro group or timer group itself is restored, not the macros or timers it contained. You will need to record the macros and set the timers again in Edit mode.

7. Recording Macros and Setting Timers

A macro allows you to send a sequence of IR commands using a single button.

When you select MACRO in the Macro menu, seven macro groups (DVD, GAME, etc.) appears by default. Each group includes buttons that allow you to record a sequence of commands. In the macro menu, there are two other macro groups (POWER and SOURCE).



Power

When you select POWER in the macro menu, you see the touch screen that appears when

you tap  in the home menu panel. Commands for turning several A/V devices on or off at the same time are recorded in each power group button. A command a single device on or off is recorded in the corresponding device button.

Source

When you select SOURCE in the macro menu, you see the touch screen that appears when

tapping  or  in the home menu panel. A command to switch the device control panel (and to switch the input of only the amplifier, not of all devices) is recorded in each device button.



You can enhance and customize macros by recording new commands and editing them.

With a timer you can activate a device at the time you determine.

Note To record a macro or set a timer, there must be at least one macro group or timer group in the Macro menu. To create these groups, see "Organizing macros and timers into groups" on page 31.

Getting the most out of it

Recording macros

- 1 Tap the Macro menu button .
- 2 Open the macro menu and select a macro group.
- 3 Switch to Edit mode via the Mode button .
Empty macro buttons appear in the macro control panel.
- 4 Tap the button you want to use for your macro.
- 5 Enter the sequence of commands you want to record.
You can navigate to any control panel you want, just as you do in Use mode.

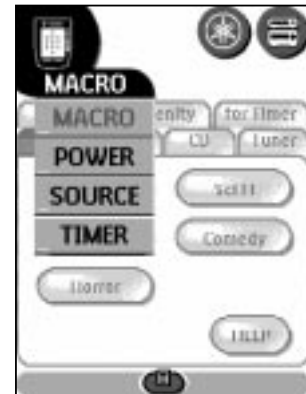

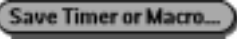
- Use scroll buttons when switching to another page within the same device. Do not tap the item tab that corresponds to each command group (as you do with the DSP, INPUT tab, etc., that appear in the AMP control panels).
- 6 Tap the Macro menu button.
The contents of the macro appear. You can now play, edit or close the macro.
 - 7 Press the Left button to close the macro.
A confirmation screen appears that enables you to save or cancel the macro.
 - 8 Tap .
The macro is ready for use.

There are two extra commands you can record in a macro:

Source switching

To record a device action that includes a source switching command, open the Device menu, hold down the Right button (labeled *Action*) and tap the device to which you want to switch.

Ending with a device control panel

To end a macro with the display of a device, open the Device menu, hold down the Left button (labeled *Device*) and tap the device you want.

■ Adding a device to a power group

Select POWER on the macro menu in step 2 and tap the button that corresponds to the device to which you want to assign the power on/off command in step 4. Then tap the power on/off button in the device control panel in step 5.

Editing macros

You can edit any macro you have recorded.





- 1 Open the macro group that contains the macro.
- 2 Switch to Edit mode via the Mode button .
- 3 Tap the macro you want to edit.

The contents of the macro appear.

- 4 Edit the macro.

You can move or delete listed commands or record new commands.



You can also add delays to the macro (for example, to insert a short pause between turning on a device and sending commands to it, allowing the device to warm up).

- 1 Tap Delay.
- 2 Tap  or  to decrease or increase the length of the delay.
- 3 Use the arrow buttons  and  to move the delay to the right position in the sequence.
- 5 Press the Left button to close the macro.
A confirmation screen appears that enables you to save or cancel the macro.
- 6 Tap .



Setting timers

To activate a device at a desired time, you can use the timer.

- 1 Tap the Macro menu button .
- 2 Open the macro menu and select a timer group.
- 3 Switch to Edit mode via the Mode button .
- 4 Tap the button for which you want to set a timer.
The first timer control panel appears, enabling you to set the start time.

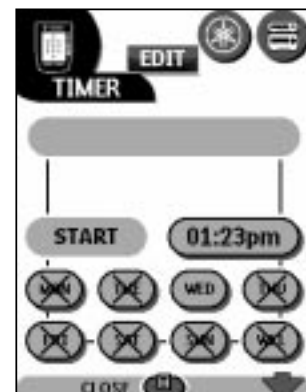

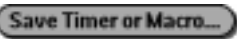

Getting the most out of it

- 5 Enter the command the timer should execute and tap the macro menu button.
A timer can contain either a single IR command or a macro.
You can navigate to any control panel you want, just as you do in Use mode.
- 6 Tap the clock button and set the start time using the Left/Right buttons.
- 7 Tap one or more day buttons to select or deselect days for the timer.
You can choose to repeat the timer weekly.
- 8 Scroll down to display the second timer control panel, in which you can set the stop time.
- 9 Enter the command the timer should execute and tap the macro menu button.
- 10 Tap the clock button and set the stop time using the Left/Right buttons.
- 11 Tap the clock button to deselect it and press the left button to close the timer.
A confirmation screen appears, enabling you to save or cancel the timer.
- 12 Tap .
The timer is activated.

Note The timer works only when the Remote Control's sending eye is pointed at the controlled device and no obstructions interfere with the IR signal.

Editing timers

You can edit any timer you have set.

- 1 Open the timer group that contains the timer.
- 2 Switch to Edit mode via the Mode button .
- 3 Tap the timer you want to edit.
The contents of the timer appear.
- 4 Edit the timer.
- 5 Press the Left button to close the timer.
A confirmation screen appears, enabling you save or cancel the timer.
- 6 Tap .
The timer is edited.

Organizing macros and timers into groups

You can create as many macro groups or timer groups as you like. Each group can contain up to 25 macros or timers.

1 Open any macro or timer group.

2 Switch to Add mode via the Mode button .

You can create a new group, copy an existing group, or restore a previously-deleted group.

- Create a new group: You add a new group in which you can record new macros.
- Copy an existing group: You copy a group and its macros and use the copy to create new macros.
- Restore a previously-deleted group: You restore a deleted group and reuse the macros.

3 Tap Create Timer Group or Create Macro Group.

You see a touch screen on which you can create and edit macro groups or timer groups. The new group is added to the macro menu.

Getting the most out of it

8. RAVedit

If you want to personalize your Remote Control beyond its standard programming features, RAVedit is the tool for you. RAVedit is the Remote Control's companion software that you can download from <http://www.yamaha.com/>

With RAVedit you can:

- Upload and download new configurations to and from your Remote Control, using the serial cable included with your Remote Control;
 - Add, delete, modify and move control panels, devices and commands anywhere on the touch screen;
 - Save, duplicate and share configuration files, codes or devices with other Remote Controls;
 - Preview new configuration files on RAVemulator. In this way you can check the appearance of the Remote Control's interface;
 - Import new graphics to create new buttons and designs;
 - Personalize configuration files to optimize the use of your Remote Control.
- When you become familiar with RAVedit, you can achieve results like the following:

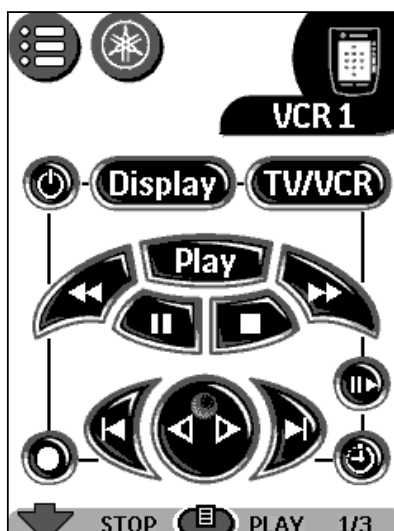
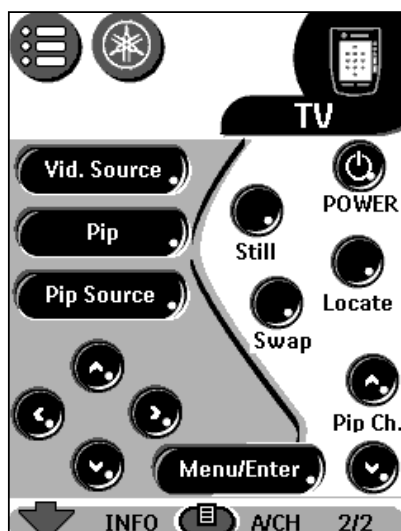

System requirements

- PC
- Windows 95/98/2000/ME or NT 4.0
- 16 MB of RAM
- 16 MB of free hard disk space
- Free serial port

Troubleshooting

General Problems

The display is blank

- Tap the screen to make sure the Remote Control is turned on.
- Adjust the contrast dial on the left side.
- Make sure the batteries are properly installed.
- Install new batteries.

The display is too light or too dark

- Adjust the contrast dial on the left side.

The Remote Control shuts itself off

- This is a feature of the Remote Control to save power. You can change the length of time the Remote Control will remain on by adjusting the Settings.

Devices do not respond to commands from the Remote Control

- Make sure the Remote Control is in Use mode.
- Make sure the Remote Control's sending eye is pointed towards the device you're operating.
- Check whether the Low Battery icon is flashing. If so, replace the batteries or recharge the battery pack.
- Check whether the button you are trying to use is programmed properly.

The Remote Control beeps 4 times after you insert the batteries

- Use RAVedit to update the Remote Control's software (RAVedit > Tools > Update RAV2000)

Programming Problems

Buttons are not sending the correct commands

- Check whether the button is programmed globally or per device.

Macros do not work

- Make sure the Remote Control's sending eye is pointed towards the device the entire time the macro is being executed.
- Insert delays to allow devices to start up properly.
- Check to ensure you have not included inactive buttons in your macro.
- Check to ensure you have not reprogrammed the buttons. Macros actually record buttons, not commands. If you reprogram a recorded button, the macro executes the new command assigned to the button.

Appendix

The TV goes blank or the input source changes

- The Device menu item might be programmed to switch the input source. Operate the device without affecting the input source.

The Remote Control won't edit, label or delete commands

- If the label locked indicator appears, the device control panels have been locked to prevent unwanted changes. You cannot modify or delete commands for this device.
- Make sure your devices are appropriately located. Avoid programming the Remote Control under bright fluorescent light: it might affect the infrared signals.
- Make sure the button you want to edit has a shade. Shadeless buttons cannot be programmed.

The Remote Control won't switch modes

- When the batteries are low the Remote Control prevents you from switching to customizing modes so that no customization can be lost. Replace the batteries.

The Remote Control is low on memory

- The Remote Control displays a message indicating it is time to clean up the memory. The Remote Control will do this by permanently removing devices and macro and timer groups you have deleted.

Warning *Cleaning up memory can take 10 minutes or longer. Never remove batteries during the clean-up process. This might damage the configuration file, resulting in loss of your customized commands..*

The configuration file is corrupted

- When this very unlikely event occurs, you have to revert to the original configuration. All your customized commands devices and macros are lost. You must reprogram your Remote Control.

Remote Control error messages

- If one of the following error messages is displayed, please contact your dealer or the YAMAHA customer service:
 - Can't open configuration file
 - Configuration file error
 - No configuration file found
 - Invalid configuration file version

FAQ

Can I program a button to execute more than one command?

No, you can't. However, you can create a macro to execute a sequence of commands.

How do I program source switching?

See "Learning device actions" on page 19.

How can I edit, label or delete buttons on home panels?

You can do this via the Device menu items. All changes you make to these items are automatically updated in the Home menu.

How do I reset the Remote Control?

Normally, you never have to reset the Remote Control. However, if the Remote Control's display freezes or if you notice unusual behavior, you might need to reset. You will not lose any saved programmed commands or macros.

- Carefully press the reset button on the back of the Remote Control with a paperclip or sharp pencil.

The Remote Control restarts and beeps to indicate it is ready for use.

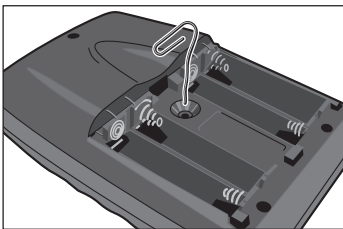

How do I revert to the original configuration?

Reverting to the original configuration restores the Remote Control's devices and commands to its state when you purchased it. This means that all programming is lost permanently. Normally, you never have to revert the Remote Control.

- 1 Touch and hold the Remote Control icon for a few seconds.
The first setup panel appears.
- 2 Scroll to the second setup panel.
- 3 Tap the Revert button.
- 4 Tap Revert to confirm the action.

Appendix

How do I calibrate the touch screen?

The Remote Control is calibrated when it leaves the factory, so normally you do not have to calibrate it yourself. It is possible that the Remote Control will display a message requesting that you calibrate the touch screen. If this message appears, do the following:

You will first see the instruction "Touch TOP LEFT corner" and then "Touch BOTTOM RIGHT corner".

- 1 Tap as close as possible to the upper left corner using the blunt tip of a pencil.
- 2 Tap as close as possible to the upper right corner using the blunt tip of a pencil.

Specifications

Hardware	<p><i>High-resolution (320 x 240) liquid crystal display (LCD) with contrast control</i></p> <p><i>Large touch screen</i></p> <p><i>Seven programmable direct-access buttons</i></p> <p><i>Backlighting for LCD and direct-access buttons</i></p> <p><i>Built-in YAMAHA RC codes</i></p> <p><i>Infrared sending and learning eyes</i></p> <p><i>3-wire (RS232) serial port connector</i></p> <p><i>Database with RC codes to operate different brands</i></p>
Software	<p><i>Dynamic, animated interface</i></p> <p><i>Editable macros (up to 255 commands per macro)</i></p> <p><i>Total number of devices and macros limited only by memory</i></p>
Infrared (IR)	<p><i>Operating distance of 10 meters (33 feet)</i></p> <p><i>Learning frequency up 56 KHz</i></p> <p><i>Learning distance 2,5 cm (1 inch) up to 30 cm (1 foot)</i></p>
Memory	<p><i>Non-volatile flash memory (retains commands when batteries are not present)</i></p> <p><i>512 K SRAM</i></p>
Batteries	<p><i>4 AA 1,5V batteries</i></p>
Battery life	<p><i>Approximately 6 months with typical use</i></p>
Power management	<p><i>Power on by tapping the touch screen, power off automatically</i></p>
Dimensions	<p><i>136mm x 93mm x 38mm (5.4 inch x 3.7 inch x 1.5 inch)</i></p>
Operating temperature	<p><i>5°C to 40°C (41°F to 104°F)</i></p>
Accessories	<p><i>Computer Interface Cable (RS-232C)</i></p> <p><i>Owner's manual</i></p> <p><i>Four AA 1.5V Batteries</i></p>

The specifications and design of this project are subject to change without notice.

Database information:

Designed by UEI Technology

Licensed under U.S. Patent 5,689,353

Portions © UEI 1999



YAMAHA ELECTRONICS CORPORATION, USA 6660 ORANGETHORPE AVE., BUENA PARK, CALIF. 90620, U.S.A.

YAMAHA CANADA MUSIC LTD. 135 MILNER AVE., SCARBOROUGH, ONTARIO M1S 3R1, CANADA

YAMAHA ELECTRONIK EUROPA G.m.b.H. SIEMENSSTR. 22-34, 25462 RELINGEN BEI HAMBURG, F.R. OF GERMANY

YAMAHA ELECTRONIQUE FRANCE S.A. RUE AMBROISE CROIZAT BP70 CROISSY-BEAUBOURG 77312 MARNE-LA-VALLEE CEDEX02, FRANCE

YAMAHA ELECTRONICS (UK) LTD. YAMAHA HOUSE, 200 RICKMANSWORTH ROAD WATFORD, HERTS WD1 7JS, ENGLAND

YAMAHA SCANDINAVIA A.B. J A WETTERGRENS GATA 1, BOX 30053, 400 43 VÄSTRA FRÖLUNDA, SWEDEN

YAMAHA MUSIC AUSTRALIA PTY, LTD. 17-33 MARKET ST., SOUTH MELBOURNE, 3205 VIC., AUSTRALIA

YAMAHA CORPORATION

Printed in Belgium **UP** VIDEO V744090